

LIST PRICE CATALOG
EFFECTIVE MAY 20, 2008

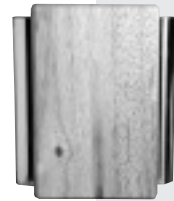

L e e E l e c t r i c

Illustrated Price Catalog

Manufacturers of
Signaling Devices,
Bells and Buzzers,
Transformers, Electric
Door Strikes, and
Electrical Specialties



Lee Electric, Inc.
309-11 51st Street
West New York, NJ 07093-0238
201-866-3656 800-433-3417
Fax No.: 201-866-0735
www.leeelectric.com

CONDITIONS OF SALE DISTRIBUTORS AND OTHER COMMERCIAL CUSTOMERS

NOTE: *The following Conditions of Sale are subject to change. All Sales Transactions are subject to the latest published Conditions of Sale of Lee Electric, Inc. and to any Special Conditions of Sale which may be contained in applicable Lee quotations and acknowledgments. Modified consumer product warranties are provided to consumers.*

1. ACCEPTANCE, GOVERNING PROVISIONS, AND CANCELLATIONS.

No order for Lee equipment or services shall be binding upon Lee until accepted by a writing of an authorized official of Lee or by shipment or other performance of such order. Any such order shall be subject to these Conditions of Sale, and acceptance shall be expressly conditioned on assent to such Conditions, which assent shall be deemed given unless purchaser shall expressly notify Lee to the contrary prior to any shipment or other performance of an order by Lee and, in any event, within five (5) days after receipt of any acknowledgement or confirmation of such order.

No order accepted by Lee may be altered or modified by purchaser unless agreed to in a writing signed by an authorized official of Lee; and no such order may be cancelled or terminated except upon payment of Lee's loss, damage and expense arising from such cancellation or termination.

No modified or other conditions will be recognized by Lee unless specifically agreed to in writing and failure of Lee to object to provisions contained in any purchase order or other communication from a purchaser (including, without limitation, penalty clauses of any kind) shall not be construed as a waiver of these Conditions nor an acceptance of any such provisions.

Unless otherwise agreed in writing by a duly authorized representative of Lee, products sold hereunder are not intended for use in or in connection with a nuclear facility or activity. If so used, Lee disclaims all liability for any nuclear damage, injury or contamination, and purchaser shall indemnify Lee against any such liability, whether as a result of breach of contract, warranty, tort (including negligence) or otherwise.

Any contract for sale and these Conditions shall be governed by and construed according to the laws of the State of New Jersey.

2. QUOTATIONS AND PRICES. Written quotations are conditioned upon acceptance by purchaser within thirty (30) days from date issued and shall be considered as offers by Lee to sell during such thirty (30) day period unless sooner terminated by notice. Other Lee publications are maintained as sources of general information and are not quotations or offers to sell.

All prices are subject to change without notice. In the event of a net price change, the price of equipment on order but unshipped will be adjusted to the price in effect at the time of shipment. Downward adjustment of prices shall apply only to unshipped portions of outstanding orders.

Except as may otherwise be stated in quotations, discount schedules, catalogs, or other Lee publications, orders amounting to less than \$ 50.00 net will be billed at \$ 50.00.

All clerical errors are subject to correction.

3. PAYMENT TERMS. Terms of payment for Lee products to purchasers of satisfactory credit are either (1) 2% cash discount for payment by the 10th proximo and net invoice amount for payment by the 25th proximo or (2) net 30 days. Applicable terms of payment are stated in quotations or on the discount sheet for the product involved.

Lee reserves the right at any time to demand full or partial payment before proceeding with a contract of sale if, in its judgement, the financial condition of purchaser shall not justify the terms of payment specified. If delivery is delayed or deferred by purchaser beyond the scheduled date, payment shall be due in full when Lee is prepared to ship and the equipment may be stored at the risk and expense of purchaser. If purchaser defaults when any payment is due, then the whole contract price shall become due and payable upon demand, or Lee, at its option, without prejudice to other lawful remedies, may defer delivery or cancel the contract for sale.

4. TAXES AND OTHER CHARGES. Any manufacturer's tax, retailer's occupation tax, use tax, sales tax, excise tax (except the Federal excise tax on vehicles), duty, custom, inspection or testing fee, or other tax, fee or charge of any nature whatsoever, imposed by any governmental authority, on or measured by any transaction between Lee and purchaser, shall be paid by purchaser in addition to the prices quoted or invoiced. In the event Lee shall be required to pay any such tax, fee or charges, purchaser shall reimburse Lee therefore; or, in lieu of such payment, purchaser shall provide Lee at the time the order is submitted with an exemption certificate or other document acceptable to the authority imposing the same. Purchase orders must state the existence and amount of any such tax, fee or charge which it shall be Lee's responsibility to collect from purchaser and pay.

5. DELIVERY. Delivery of equipment to a carrier at any Lee facility or other shipping point shall constitute delivery to purchaser; and, regardless of freight payment, title and all risk of loss or damage in transit shall pass to purchaser at that time.

Great care is taken in packing Lee equipment. Lee cannot be held responsible for breakage after having received "in good order" receipts from the transportation company. All claims for loss and damage must be made by purchaser to the carrier.

Claims for shortages or other errors must be made in writing to Lee within 15 days after receipt of shipment, and failure to give such notice shall constitute unqualified acceptance and a waiver of all such claims by purchaser.

Except as may otherwise be stated in quotations, discount schedules, catalogs, or other Lee publications, freight will be allowed to the common carrier free delivery point nearest the destination on shipments within **THE UNITED STATES EXCLUDING ALASKA AND HAWAII**, except that such freight shall be prepaid but not allowed on shipments of Lee products having a net invoice price of less than Two Hundred Dollars (\$200).

No allowance will be made in lieu of transportation if purchaser accepts shipment at factory, warehouse, freight station, or otherwise supplies its own transportation.

Method and route of shipment will be at the discretion of Lee unless purchaser shall specify otherwise, and any additional expense of the method or route of shipment specified by purchaser shall be borne by purchaser.

Lee reserves the right to make delivery in installments, unless otherwise expressly stipulated in the contract for sale; and all such installments when separately invoiced shall be paid for when due per invoice, without regard to subsequent deliveries. Delay in delivery of any installment shall not relieve purchaser of its obligations to accept remaining deliveries. Lee shall not be liable for any damage as a result of any delay due to any cause beyond Lee's reasonable control, including, without limitation, an act of God; act of purchaser or Lee's supplier; embargo or other governmental act, regulation or request; fire; accident; strike; slowdown; war; riot; delay in transportation; and inability to obtain necessary labor, materials or manufacturing facilities. In the event of any such delay, the date of delivery shall be extended for a period equal to the time lost by reason of the delay.

6. SUBSTITUTES. Lee may furnish suitable substitutes for materials unobtainable because of priorities or regulations established by governmental authority or nonavailability of materials from suppliers, and assumes no liability for deviation from published dimensions and descriptive information not essential to proper performance of the product.

7. WARRANTIES TO DISTRIBUTORS AND OTHER COMMERCIAL CUSTOMERS. Lee warrants equipment manufactured by it to be free from defects in materials and workmanship for a period of one (1) year from date of shipment by Lee. If within such period any such equipment shall be proved to Lee's satisfaction to be so defective, such equipment shall be repaired or replaced at Lee's option. This warranty shall not apply (a) to equipment not manufactured by Lee, (b) to equipment which shall have been repaired or altered by Lee so as, in its judgement, to affect the same adversely, or (c) to equipment which shall have been subjected to negligence, accident or damage by circumstances beyond Lee's control, or to improper operation, maintenance or storage, or to other than normal use or service. Lee shall in all respects conform and be limited to the warranty actually extended to Lee by its supplier. The foregoing warranties do not cover reimbursement for transportation, removal, installation, or other expenses which may be incurred in connection with repair or replacement.

Except as may be expressly provided in an authorized writing by Lee, Lee shall not be subject to any other obligations or liabilities whatsoever with respect to equipment manufactured by Lee or services rendered by Lee.

THE FOREGOING WARRANTIES ARE EXCLUSIVE AND IN LIEU OF ALL OTHER EXPRESS AND IMPLIED WARRANTIES EXCEPT WARRANTIES OF TITLE, INCLUDING BUT NOT LIMITED TO IMPLIED WARRANTIES OF MERCHANTABILITY AND FITNESS FOR A PARTICULAR PURPOSE.

8. LIMITATION OF LIABILITY. Anything to the contrary herein contained notwithstanding, **LEE ELECTRIC, INC., ITS CONTRACTORS AND SUPPLIERS OF ANY TIER, SHALL NOT BE LIABLE IN CONTRACT, IN TORT (INCLUDING NEGLIGENCE OR STRICT LIABILITY OR OTHERWISE FOR ANY SPECIAL, INDIRECT, INCIDENTAL OR CONSEQUENTIAL DAMAGES WHATSOEVER.** The remedies of the purchaser set forth herein are exclusive are so stated and the total cumulative liability of Lee, its contractors and suppliers of any tier, with respect to this contract or anything done in connection therewith, such as the use of any product covered by or furnished under the contract, whether in contract, in tort (including negligence or strict liability) or otherwise, shall not exceed the price of the product or part on which such liability is based.

9. RETURN OF EQUIPMENT: No equipment may be returned without first obtaining Lee's written permission and a returned material identification tag.









Equipment accepted for credit, not involving a Lee error, shall be subject to a minimum service charge of \$20.00 or 20% of the invoice price, whichever is greater, plus all transportation charges incurred by Lee.

Returned equipment must be securely packed to reach Lee without damage, any cost incurred by Lee to put equipment in first class condition will be charged to purchaser.









10. PATENTS. As to equipment proposed and furnished by Lee, Lee shall defend any suit or proceeding brought against purchaser so far as based on a claim that said equipment constitutes an infringement of any patent of the United States, if notified promptly in writing and given authority, information, and assistance at Lee's expense for the defense of the same. In event of a final award of costs and damages, Lee shall pay such award. In event the use of said equipment by purchaser is enjoined in such a suit, Lee shall, at its own expense, either (a) procure for purchaser the right to continue using said equipment, (b) modify said equipment to render it non-infringing, (c) replace said equipment with non-infringing equipment, or (d) refund the purchase price (less depreciation) and the transportation and installation costs of said equipment. Lee will not be responsible for any compromise or settlement made without its written consent.









The foregoing states the entire liability of Lee for patent infringement, and in no event shall Lee be liable if the infringement charge is based on the use of Lee equipment for a purpose of other than that for which sold by Lee. As to any equipment furnished by Lee to purchaser and manufactured in accordance with designs proposed by purchaser, purchaser shall indemnify Lee against any award made against Lee for patent, trademark, or copyright infringements.

11. PATTERNS AND TOOLS. Notice will be given if special patterns or tools are required to complete any order. Charges for such patterns or tools do not convey title thereto or the right to remove them from Lee's plant. If patterns or tools are not used for a period of two years, Lee shall have the right to scrap them without notice.







Catalog No.	Description	Std. Qty.	Pkg. Weight	List Price		
BLISTER CARDED PUSH BUTTONS						
*These BC (Blister Carded) items are also available boxed at same price. Omit BC when ordering. Low voltage: Lighted to 16V AC; unlighted to 24V AC.						
	*BC 200	1 3/4" Round, Sprayed Brass	10	1 lb.	3.95	
	*BC 200 C	1 3/4" Round, Chrome	10	1 lb.	4.80	
	*BC 200 P	1 3/4" Round, Polished Brass	10	1 lb.	4.80	
	BC 200 LG	1 3/4" Round, Gold, Lighted	10	1 lb.	8.85	
	*BC 201	2 1/4" Round, Sprayed Brass	10	1 lb.	4.20	
	*BC 201 C	2 1/4" Round, Chrome	10	1 lb.	5.05	
	*BC 201 P	2 1/4" Round, Polished Brass	10	1 lb.	5.05	
	BC 201 LG	2 1/4" Round, Gold, Lighted	10	1 lb.	8.90	
	BC 202	Single Nameplate, Sprayed Brass	2" x 2 9/16"	10	1 lb.	7.45
	BC 203	Two Gang Nameplate, Sprayed Brass	1 5/8" x 4 3/4"	10	2 lbs.	9.80
	BC 203 C	Two Gang Nameplate, Chrome	1 5/8" x 4 3/4"	10	2 lbs.	13.15
	BC 203 P	Two Gang Nameplate, Polished Brass	1 5/8" x 4 3/4"	10	2 lbs.	13.15
	BC 204 G-1	Gold Escutcheon Unlit Button for Stucco	2 1/2" Dia.	10	1 lb.	6.80
	BC 204 G-2	Gold Escutcheon Unlit Button for Stucco w/Plastic Sleeve		10	1 lb.	8.80
	BC 204 LG-1	Gold Escutcheon Lighted Button for Stucco	2 1/2" Dia.	10	1 lb.	9.15
	BC 204 LG-2	Gold Escutcheon Lighted Button for Stucco w/Plastic Sleeve		10	1 lb.	11.60
	BC 204 S-1	Silver Escutcheon Unlit Button for Stucco	2 1/2" Dia.	10	1 lb.	6.80
	BC 204 S-2	Silver Escutcheon Unlit Button for Stucco w/Plastic Sleeve		10	1 lb.	8.80
	BC 204 LS-1	Silver Escutcheon Lighted Button for Stucco	2 1/2" Dia.	10	1 lb.	9.15
	BC 204 LS-2	Silver Escutcheon Lighted Button for Stucco w/Plastic Sleeve		10	1 lb.	11.60
	BC 204-PS	Plastic Wiring Sleeve for 204 G or LG	S or LS	10	1 lb.	3.20
	*BC 205 B	5/8" Push Button, Brass		10	1/4 lb.	3.15
	*BC 205 C	5/8" Push Button, Chrome		10	1/4 lb.	3.15
	*BC 205 LB	5/8" Pearl Push Button, Brass, Lighted		10	1/4 lb.	5.40
	*BC 205 LC	5/8" Pearl Push Button, Chrome, Lighted		10	1/4 lb.	5.40



Catalog No.	Description	Std. Qty.	Pkg. Weight	List Price
BLISTER CARDED PUSH BUTTONS (Continued)				
	BC 208 Three Gang Nameplate, Sprayed 1 5/8" x 7"	10	2 lbs.	17.15
	BC 208 C Three Gang Nameplate, Chrome, Bagged with Header 1 5/8" x 7"	10	2 lbs.	22.55
	BC 208 P Three Gang Nameplate, Polished Brass 1 5/8" x 7"	10	2 lbs.	22.55
	BC 215 B Oblong Escutcheon 2" x 1 5/8" Brass Finish	10	3/4 lb.	6.05
	BC 215 C Oblong Escutcheon 2" x 1 5/8" Chrome	10	3/4 lb.	6.05
	BC 215 LB Oblong Escutcheon 2" x 1 5/8" Brass Finish, Lighted	10	3/4 lb.	9.30
	BC 215 LC Oblong Escutcheon 2" x 1 5/8" Chrome, Lighted	10	3/4 lb.	9.30
	BC 219 Narrow Door Jamb Push Button, Sprayed Brass Finish 7/8" x 2 3/4"	10	1/2 lb.	4.30
	BC 219 C Narrow Door Jamb Push Button, Chrome 7/8" x 2 3/4"	10	1/2 lb.	4.95
	BC 219 P Narrow Door Jamb Push Button, Polished Brass 7/8" x 2 3/4"	10	1/2 lb.	4.95
	BC 219 W Narrow Door Jamb Push Button, White 7/8" x 2 3/4"	10	1/2 lb.	4.30
	BC 260 C 1 7/8" Round, Chrome Finish	10	14 oz.	6.00
	BC 260 P 1 7/8" Round, Brass Finish	10	14 oz.	6.00
	BC 260 LB 1 7/8" Round, Brass Finish, Lighted	10	14 oz.	7.80
	BC 260 LC 1 7/8" Round, Chrome Finish, Lighted	10	14 oz.	7.80
	BC 262 P 2 7/8" x 1 3/16" Rectangle, Brass Finish	10	14 oz.	6.25
	BC 262 LB 2 7/8" x 1 3/16" Rectangle, Brass Finish, Lighted	10	14 oz.	9.60
	BC 263 C 3 7/8" x 2" Star, Chrome Finish	10	1 lb.	8.80
	BC 263 P 3 7/8" x 2" Star, Brass Finish	10	1 lb.	8.80
	BC 263 LB 3 7/8" x 2" Star, Brass Finish, Lighted	10	1 lb.	11.90
	BC 263 LC 3 7/8" x 2" Star, Chrome Finish, Lighted	10	1 lb.	11.90
	BC 264 C Diamond or Square, Chrome Finish, Unlighted 2 1/2" x 2 1/2"	10	14 oz.	6.00
	BC 264 LC Diamond or Square, Chrome Finish, Lighted 2 1/2" x 2 1/2"	10	14 oz.	8.70
	BC 265 B Slim Bar Type Metal, Gold, Unlighted 2 3/4" x 1 1/16"	10	1 lb.	5.60
	BC 265 C Slim Bar Type Metal, Silver, Unlighted 2 3/4" x 1 1/16"	10	1 lb.	5.60
	BC 265 LG Slim Bar Type Metal, Gold, Lighted 2 3/4" x 1 1/16"	10	1 lb.	7.30
	BC 265 LS Slim Bar Type Metal, Silver, Lighted 2 3/4" x 1 1/16"	10	1 lb.	7.30
	BC 265 LW Slim Bar Type Metal, White, Lighted 2 3/4" x 1 1/16"	10	1 lb.	7.30

Catalog No.	Description	Std. Qty.	Pkg. Weight	List Price
BLISTER CARDED PUSH BUTTONS (Continued)				
	BC 266 BLK Slim Bar Type, 2 ¹³ / ₁₆ " x 7/8", Black, Unlighted	10	1 lb.	4.95
	BC 266 BRN Slim Bar Type, 2 ¹³ / ₁₆ " x 7/8", Brown, Unlighted	10	1 lb.	4.95
	BC 266 W Slim Bar Type, 2 ¹³ / ₁₆ " x 7/8", White, Unlighted	10	1 lb.	4.95
	BC 266 B Slim Bar Type, 2 ¹³ / ₁₆ " x 7/8", Gold, Unlighted	10	1 lb.	4.95
	BC 266 C Slim Bar Type, 2 ¹³ / ₁₆ " x 7/8", Silver, Unlighted	10	1 lb.	4.95
	BC 266 LG Slim Bar Type, 2 ¹³ / ₁₆ " x 7/8", Gold, Lighted	10	1 lb.	6.40
	BC 266 LS Slim Bar Type, 2 ¹³ / ₁₆ " x 7/8", Silver, Lighted	10	1 lb.	6.40
	BC 266 LBRN Slim Bar Type, 2 ¹³ / ₁₆ " x 7/8", Brown, Lighted	10	1 lb.	6.40
BC 266 LW Slim Bar Type, 2 ¹³ / ₁₆ " x 7/8", White, Lighted	10	1 lb.	6.40	
	BC 267 LG Single Lighted Name, 2 ⁵ / ₁₆ " x 1 ³ / ₈ ", Gold	10	1 1/4 lbs.	14.80
	BC 267 LS Single Lighted Name, 2 ⁵ / ₁₆ " x 1 ³ / ₈ ", Silver	10	1 1/4 lbs.	14.80
	BC 268 LG Double Lighted Name, 5 1/4" x 1 3/8", Gold	10	2 1/2 lbs.	19.75
	BC 268 LS Double Lighted Name, 5 1/4" x 1 3/8", Silver	10	2 1/2 lbs.	19.75
	BC 269 LG Triple Lighted Name, 7 9/16" x 1 3/8", Gold,	10	3 lbs.	29.60
	BC 269 LS Triple Lighted Name, 7 9/16" x 1 3/8", Silver,	10	3 lbs.	29.60
<i>One price applies regardless of finish. Indicate finish when ordering BC 270 through BC 277.</i>				
	BC 270 Castillian 2" Diameter, Lighted White & Polished Brass White & Polished Chrome Black & Pewter	10	1 1/2 lbs.	11.15
	BC 271 Mandarin 2" x 2", Lighted Black & Polished Brass White & Gold Black & Pewter	10	1 1/2 lbs.	11.15
	BC 272 Medallion 2" Diameter, Lighted Black & Polished Brass Black & Gold	10	1 1/2 lbs.	11.15
	BC 273 Versailles 5 1/2" x 1", Lighted White & Polished Brass White & Polished Chrome Black & Pewter	10	1 1/2 lbs.	11.15

Catalog No.	Description	Std. Qty.	Pkg. Weight	List Price		
BLISTER CARDED PUSH BUTTONS (Continued)						
<i>One price applies regardless of finish. Indicate finish when ordering BC 270 through BC 277.</i>						
	BC 274 Corinthian 5" x 1 1/4", Lighted White & Polished Chrome Black & Pewter	10	1 1/2 lbs.	11.15		
	BC 276 Shield 3 1/2" x 1 1/2", Lighted Antique Iron Antique Brass	10	1 1/2 lbs.	11.15		
	BC 277 Fleur de Lis 5 3/8" x 1", Lighted Antique Iron Antique Brass Bright Gold	10	2 lbs.	12.50		
	BC 278 Femina 3 1/2" x 1 1/8", Lighted Antique Gold	10	2 lbs.	12.50		
DECORATOR PUSH BUTTONS (Lighted)						
<i>Available in Polished Brass or Pewter</i>						
	BC 285 LB Buckingham	Brass	4 1/2" x 1 1/4"	6	3 lbs.	13.80
	BC 285 LC Buckingham	Pewter	4 1/2" x 1 1/4"	6	3 lbs.	13.80
	BC 286 LB Regent	Brass	2 3/4" x 1 1/4"	6	1 1/2 lbs.	9.85
	BC 286 LC Regent	Pewter	2 3/4" x 1 1/4"	6	1 1/2 lbs.	9.85
	BC 287 LB Churchill	Brass	3" x 1 1/4"	6	1 1/2 lbs.	11.10
	BC 287 LC Churchill	Pewter	3" x 1 1/4"	6	1 1/2 lbs.	11.10
	BC 288 LB Oxford	Brass	3 9/16" x 1 5/16"	6	1 1/2 lbs.	9.85
	BC 288 LC Oxford	Pewter	3 9/16" x 1 5/16"	6	1 1/2 lbs.	9.85

Catalog No.	Description			Std. Qty.	Pkg. Weight	List Price
BLISTER CARDED PUSH BUTTONS (Continued)						
DECORATOR PUSH BUTTONS (Lighted)						
Available in Polished Brass or Pewter						
	BC 289 LB	Windsor	Brass	27/8" x 1 1/4"	6	1 1/2 lbs. 11.10
	BC 289 LC	Windsor	Pewter	27/8" x 1 1/4"	6	1 1/2 lbs. 11.10
	BC 290 LB	Lancaster	Brass	3 1/4" x 1 1/4"	6	2 lbs. 12.35
	BC 290 LC	Lancaster	Pewter	3 1/4" x 1 1/4"	6	2 lbs. 12.35
	BC 291 LCLR	Lighted clear replacement push button for BC285 through BC290 Series <i>See page 19 for display information.</i>			6	1 lb. 5.40
	BC 292 LW	Spindletop White Lighted		1" x 4 1/2"	6	1 lb. 11.10
	BC 292 LAB	Spindletop Antique Brass Lighted		1" x 4 1/2"	6	1 lb. 11.10
Mini-Estate – Surface Mounted – Lighted						
	BC 293 LSS	Stainless Steel		15/16" x 3 1/4"	6	1 lb. 12.70
	BC 293 LMBLK	Matte Black		15/16" x 3 1/4"	6	1 lb. 12.70
	BC 293 LPB	Polished Brass		15/16" x 3 1/4"	6	1 lb. 12.70
	BC 293 LPW	Pewter		15/16" x 3 1/4"	6	1 lb. 12.70
	BC 293 LRB	Rustic Brick		15/16" x 3 1/4"	6	1 lb. 12.70
	BC 293 LMW	Matte White		15/16" x 3 1/4"	6	1 lb. 12.70
	BC 293 LWBZ	Weathered Bronze		15/16" x 3 1/4"	6	1 lb. 12.70
<i>See Page 20 for Display information.</i>						
	BC 601 BR	Cast Brass Push Button Plate, 3 3/4" x 1 1/2", Unlighted			10	1 3/4 lbs. 6.25
	BC 601 BLK	Cast Black Push Button Plate, 3 3/4" x 1 1/2", Unlighted			10	1 3/4 lbs. 6.25
	BC 601 W	Cast Push Button Plate, 3 3/4" x 1 1/2", White, Unlighted			10	1 3/4 lbs. 6.25
	BC 601 L BR	Cast Brass Push Button Plate, 3 3/4" x 1 1/2", Lighted			10	1 3/4 lbs. 8.65
	BC 601 L BLK	Cast Black Push Button Plate, 3 3/4" x 1 1/2", Lighted			10	1 3/4 lbs. 8.65
	BC 601 LW	Cast Push Button Plate, 3 3/4" x 1 1/2", White, Lighted			10	1 3/4 lbs. 8.65
	BC 666 B	Plastic Button Black – Ivory Bar		2 3/4" x 3/4"	10	1 lb. 2.95
	BC 666 P	Plastic Button Gold Body – Ivory Bar		2 3/4" x 3/4"	10	1 lb. 3.40
	BC 666 W	Plastic Button Ivory – Black Bar		2 3/4" x 3/4"	10	1 lb. 2.95
	BC 666 S	Plastic Button Silver Body – Black Bar		2 3/4" x 3/4"	10	1 lb. 3.40

Catalog No.	Description	Std. Qty.	Pkg. Weight	List Price
-------------	-------------	-----------	-------------	------------

CLAM SHELL PACKAGED TRANSFORMERS COMPLETE WITH GROUND WIRE

120V AC Primary

Cat. Nos. BC 315 - BC 592 available at lower cost. See Nos. 315 - 592.



BC 315	10 Volts, 5 VA "Lock nut type"	5	5 lbs.	14.60
--------	--------------------------------	---	--------	-------



BC 323 M	Chime Transformer 16 Volts, 10 VA "Lock nut type"	5	5 lbs.	14.60
----------	--	---	--------	-------



BC 323 M-15	Chime Transformer 16 Volts, 15 VA "Lock nut type"	5	5 lbs.	16.40
-------------	--	---	--------	-------



BC 592	Heavy Duty Trivolt 8-16-24 8 & 16 Volts - 10 VA 24 Volts - 20 VA "Lock nut type"	5	5 lbs.	24.25
--------	---	---	--------	-------

BLISTER CARDED AUDIBLE SIGNALS

8-16V AC, 3-6V DC

Cat. Nos. BC 302 - BC 305 avail. boxed at lower cost. See Nos. 302 - 305.



BC 302	2 coil Bell, Concealed Terminals, 2½" Dia. Gong	6	3 lbs.	13.00
--------	---	---	--------	-------



BC 303	2 coil Bell, Concealed Terminals, 3" Dia. Gong	6	3 lbs.	16.10
--------	--	---	--------	-------



BC 304	2 coil Bell, Concealed Terminals, 4" Dia. Gong	6	4 lbs.	18.00
--------	--	---	--------	-------



BC 305	2 coil Buzzer, Concealed Terminals	6	2 lbs.	10.65
--------	------------------------------------	---	--------	-------

Catalog No.	Description	Std. Qty.	Pkg. Weight	List Price
-------------	-------------	-----------	-------------	------------

HANGER BOXED NON-ELECTRIC CHIMES



BC 1027	Ivory – Non-Electric, One Door	3" x 7"	3	3 lbs.	24.25
BC 1027 DV	Ivory Chime & Door Viewer Non-Electric, One Door	3" x 7"	3	3 lbs.	31.10
BC 1027 DV-2	Ivory Chime with Long Door Plate & Viewer Long Plate (1 ¹⁵ / ₁₆ " x 2 ³ / ₄ ") – Non-Electric, One Door		3	3 lbs.	34.10

NON-ELECTRIC CHIMES

All LEE Door Chimes are packaged with complete fastening hardware, positioning templates and easy-to-follow instructions. LEE Chimes are designed to fit doors and walls up to 4-3/4" thick.

There are a variety of handsome decorator finishes to choose from. Each finish blends attractively with a wide range of decors.



BC 1028-685
Hotel Model,
One-Way Wide
Angle Viewing
Lens.
5" h x 2" w



BC 1028-686
One-Way Wide
Angle Viewing
Lens, Apartment
Identification,
Name Plate.
5" h x 2" w



BC 1028-687
Economy Model,
Name Plate
Only, No Viewer.
2¹/₄" h x 2" w





BC 1028-689
Modern, Deep
Recessed,
Deluxe One-Way
Viewing Mirror.
Apartment
Identification
Card, Name
Card. Heavy
Cast Metal Plate.
6⁵/₈" h x 3" w









BC 1028-685-BZ	Non-Electric Chime Bronze	5" x 2"	30	24 lbs.	24.70
BC 1028-685-GP	Non-Electric Chime Gold	5" x 2"	30	24 lbs.	24.70
BC 1028-685-SP	Non-Electric Chime Silver	5" x 2"	30	24 lbs.	24.70
BC 1028-686-BZ	Non-Electric Chime Bronze	5" x 2"	30	24 lbs.	24.70
BC 1028-686-GP	Non-Electric Chime Gold	5" x 2"	30	24 lbs.	24.70
BC 1028-686-SP	Non-Electric Chime Silver	5" x 2"	30	24 lbs.	24.70
BC 1028-687-GP	Non-Electric Chime Gold	2 ¹ / ₄ " x 2"	30	24 lbs.	20.40
BC 1028-687-SP	Non-Electric Chime Silver	2 ¹ / ₄ " x 2"	30	24 lbs.	20.40
BC 1028-689-GP	Non-Electric Chime Gold	6 ⁵ / ₈ " x 3"	30	36 lbs.	24.70
BC 1028-689-SP	Non-Electric Chime Silver	6 ⁵ / ₈ " x 3"	30	36 lbs.	24.70
BC 1028-689-GMT	Replacement Grommet		50	1/4 lb.	.27
* For U/L Viewer (BC 1028-685, BC 1028-686) add					5.45



Catalog No.	Description	Std. Qty.	Pkg. Weight	List Price
CLAM SHELL PACKAGED DECORATOR DOOR CHIMES				
<i>All Chimes 16V AC, Two Notes Front Door, One Note Rear Door, unless otherwise indicated. See Page 19 for Chime Display Information.</i>				
	BC 1032 White	7 1/4" x 4"	3	3 lbs. 20.25
	BC 1035 White & Gold	7 1/4" x 4"	3	3 lbs. 23.60
	BC 1036 White & Silver	7 1/4" x 4"	3	3 lbs. 23.60
	BC 1039 Walnut & Gold	7 1/4" x 4"	3	3 lbs. 23.60
	BC 1050 White Acrylic & Gold Tubes	9" x 7"	3	3 lbs. 34.45
	BC 1055 White Acrylic & Silver Tubes	9" x 7"	3	3 lbs. 34.45
	BC 1051 Solid Oak & Gold Tubes	9" x 7"	3	3 lbs. 45.60
	BC 1056 Solid Oak & Silver Tubes	9" x 7"	3	3 lbs. 45.60
	BC 1052 Black Acrylic & Gold Tubes	9" x 7"	3	3 lbs. 34.45
	BC 1054 Walnut & Gold Tubes	9" x 7"	3	5 lbs. 34.45
	BW 6520 Bell Wire 65 ft. #20 Bell Wire Available in 5 Colors: Red, White, Yellow, Green, Black		5	2 lbs. 8.15
	DV 22 Door Viewer 180° Brass	U/L Listed	5	1 lb. 9.95
	DV 22 Door Viewer 180° Chrome	U/L Listed	5	1 lb. 9.95
	FA-50-G Glass Replacement Rod for Cat. No. FA-50 (Packed 20 per box)		20	1/2 lb. 2.75

	Catalog No.	Description	Std. Qty.	Pkg. Weight	List Price	
	PI-12-20	Plug-in 12V AC, 20V A	For general signaling	1	1 lb.	21.60
	PI-16-20	Plug-in 16V AC, 20V A	For general signaling	1	1 lb.	21.60
	PI-24-20	Plug-in 24V AC, 20V A	For general signaling	1	1 lb.	21.60
	PI-12-40	Plug-in 12V AC, 40V A	For heavy duty signaling	1	2 lbs.	27.80
	PI-16-40	Plug-in 16V AC, 40V A	For heavy duty signaling	1	2 lbs.	27.80
	PI-24-40	Plug-in 24V AC, 40V A	For heavy duty signaling	1	2 lbs.	27.80
	PI-12-50	Plug-in 12V AC, 50V A	For post lighting	1	2 lbs.	30.25
	PI-24-50	Plug-in 24V AC, 50V A	For post lighting	1	2 lbs.	30.25
	PS-12	Plug-in Power Supply 120VA to 12 V DC 1000 Mili Amps	1	1 lbs.	18.55	
	PS-24	Plug-in Power Supply 120VA to 24 V DC 500 Mili Amps	1	1 lbs.	18.55	
	QR-1	Rectifier for Silent Operation For use up to 24V AC/DC	1	1/4 lb.	49.40	

CLAM SHELL PACKAGED WIRELESS CHIMES

	WC 100	Wireless Chime	Battery Operated Receiver Battery Operated Transmitter	6	3 lbs.	26.50
	WC 102	Wireless Chime	Plug-In Receiver Battery Operated Transmitter	6	4 lbs.	28.95
	WC 103	Wireless Chime – White with Gold Tubes	Battery Operated Receiver Battery Operated Transmitter	3	6 lbs.	40.10
	WC 107	Wireless Chime – White with Pewter Tubes		3	6 lbs.	40.10
	WC 104	Wireless Chime – Oak with Gold Tubes	Battery Operated Receiver Battery Operated Transmitter	3	6 lbs.	45.60
	WC 105	2-Entrance Wireless Chime –	Battery Operated Receiver Battery Operated Transmitter	6	4 lbs.	34.45
	WC 106	2-Entrance Wireless Chime –	Plug-in Receiver Battery Operated Transmitter	6	4 lbs.	37.60
	WC 109	Transmitter and Battery Combo for All Lee Wireless Chimes		6	2 lbs.	11.50
	BTY 103	Replacement Transmitter Battery for All Lee Wireless Chimes (1 per bag)		2	1/4 lb.	3.10

Catalog No.	Description	Std. Qty.	Pkg. Weight	List Price
ELECTRIC DOOR STRIKES				
<i>Standard Voltage 3-6V DC, 8-16V AC, unless otherwise indicated. For Solenoid Door Openers, choose either 16V AC or 24 V AC/DC</i>				
	2 Mortise Type Flat Face	5	3¼ lbs.	61.75
	2 SOL Mortise Type Flat Face Solenoid	1	1 lb.	71.65
	+2 RS Mortise Type Flat Face, Reverse Action 24V AC/DC	1	1 lb.	148.15
	2 R Mortise Type Round Face	2	1 lb.	101.25
	2 R SOL Mortise Type Round Face Solenoid	1	1 lb.	108.65
	+2 R RS Mortise Type Round Face, Reverse Action 24V AC/DC	1	1 lb.	155.60
	3 Rim Type Door Opener	5	3¾ lbs.	71.60
	4 Mortise Type Knockout	5	3¾ lbs.	75.60
	5 Mortise Type Door Opener	5	3¾ lbs.	43.85
	5 S Mortise Type, for Schlage Type Lock Set	5	5 lbs.	56.80
	6 Rim Type Door Opener	5	5 lbs.	64.20
	7 Mortise Type Door Opener	5	5 lbs.	92.60
	*12 Mortise Type ANSI Standards Brass 4 ⁷ / ₈ "	1	1 lb.	92.60
	*12 C Mortise Type ANSI Standards Chrome 4 ⁷ / ₈ "	1	1 lb.	97.60
	+12 RS Mortise Type ANSI Standards 4 ⁷ / ₈ ", Reverse Action	1	1 lb.	153.10
	+12 C RS Mortise Type ANSI Standards Chrome 4 ⁷ / ₈ " Reverse Action	1	1 lb.	159.30
	*12-407B Mortise Type Flat Face Brass 4 ⁷ / ₈ "	1	1 lb.	81.50
	*12-407C Mortise Type Flat Face Chrome 4 ⁷ / ₈ "	1	1 lb.	86.45
	<i>*Specify 16VAC, 24VAC or 24V AC/DC</i>			
	14 Mortise Type ANSI Standards 2 ³ / ₄ "	5	1½ lbs.	56.80
	14 DL Mortise Type Extra Narrow for Dead Lock Add for Chrome No. 14 Models	2	1 lb.	61.75 3.70
SEE PAGE 11 FOR MORE ELECTRIC DOOR STRIKE PRICING AND INFORMATION				

Catalog No.	Description	Std. Qty.	Pkg. Weight	List Price
SEE PAGE 10 FOR ELECTRIC DOOR STRIKE PHOTOS				
	Add for Chrome – Nos. 4, 5, 5S, 7			3.70
	Add for 24V AC – Nos. 2, 3, 4, 5, 5S, 6, 7, 14			4.95
	Add for 12V DC – Nos. 220, 2, 3, 4, 5, 5S, 6, 7, 14			4.95
	Add for 24V DC – Nos. 220, 2, 3, 4, 5, 5S, 6, 7, 14			4.95
SEE PAGE 12 FOR NO. 220 MORTISE OPENER – OUR MOST POPULAR MODEL!				
+Reverse Action means normally unlocked – power locks units (24V AC/DC only)				
For Solenoid Door Openers, choose either 16V AC or 24V AC/DC				

WEATHERPROOF BEACONS

For Indoor or Outdoor Applications

Available in: Red, Amber and Blue. Specify color when ordering.



50	Flashing Beacon 120V AC – 40 Watt	1	5 lbs.	288.15
----	-----------------------------------	---	--------	--------



51	Flashing Beacon with Horn 120V AC – 40 Watt	1	6 lbs.	344.00
----	---	---	--------	--------



52	Rotating Beacon 120V AC – 40 Watt	1	9 lbs.	293.70
----	-----------------------------------	---	--------	--------

ELECTRICAL SPECIALTIES



100	Totally Enclosed Bell, Boxed 8-16 V AC, 3-6V DC	10	6 lbs.	25.45
-----	---	----	--------	-------

101	Totally Enclosed Bell, Combination Bell-Buzzer, Boxed 8-16 V AC, 3-6V DC	10	6 lbs.	28.55
-----	---	----	--------	-------









147-1	Stainless Steel Plate for 5/8" Push Nos. 205C, 694, 695	1	1/4 lb.	11.65
-------	---	---	---------	-------

149-1	Stainless Steel Plate for Nos. 214, 850	1	1/4 lb.	11.65
-------	---	---	---------	-------







207	Doortrip Switch – Rings when Door Opens & Closes Low Voltage Only 24V AC Max.	5	1 lb.	19.75
-----	--	---	-------	-------



Catalog No.	Description	Std. Qty.	Pkg. Weight	List Price
ELECTRICAL SPECIALTIES (Continued)				
	ECONOMY DOOR LIGHT SWITCH <i>1 1/4" wide plate; 6 amp switch. 120V AC maximum.</i>			
209 DN	Door Switch – ‘On’ when Door is Open – 50 Pack	50	20 lbs.	12.35
209 DN	Door Switch – ‘On’ when Door is Open – 100 Pack	100	40 lbs.	11.15
	<i>Call factory for larger quantity pricing.</i>			
	SPECIFICATION GRADE DOOR LIGHT SWITCH <i>1 1/4" wide plate; 10 amp switch. 120V AC maximum.</i>			
210 DN	Door Switch – ‘On’ when Door is Open	25	11 lbs.	15.10
210 SW	Switch on plate with leads	10	3 lbs.	10.05
211 DF	Door Switch – ‘Off’ when Door is Open	5	3 lbs.	16.75
211 SW	Switch on plate with leads	10	3 lbs.	11.60
	<i>Call factory for larger quantity pricing.</i>			
	214 High Voltage Push, 120 Volts, Use on 7/8" Hole	5	1/2 lb.	44.60
	CAST BODY DOOR LIGHT SWITCH <i>1 3/16" wide plate; 6 amp switch. 120V AC maximum.</i>			
217 DN	Door Switch – ‘On’ when Door is Open – 50 Pack	50	29 lbs.	12.35
217 DN	Door Switch – ‘On’ when Door is Open – 100 Pack	100	57 lbs.	11.15
	<i>50 piece minimum. Call factory for larger quantity pricing.</i>			
	CAST BODY DOOR LIGHT SWITCH <i>1 3/16" wide plate; 10 amp switch. 120V AC maximum.</i>			
218 DF	Door Switch – ‘Off’ when Door is Open	5	3 lbs.	16.75
	ELECTRIC DOOR OPENER Standard Voltage 8-16V AC, 3-6V DC			
220	Mortise Door Opener	25	20 lbs.	35.60
220 SOL	Mortise Door Opener, Solenoid type (Specify 16V AC or 24V AC/DC)	1	1 lb.	44.45
220 RS	Mortise Type, Reverse Action (normally unlocked) 24V AC/DC only	1	1 lb.	111.50
220 S	Mortise Door Opener (1/4" plate for schlage lock)	1	1 lb.	74.10
	Add for Chrome No. 220			3.40
	Add for 24V AC			4.95
	244 RB *Roller Ball Contact for Open Circuit Use	10	1/4 lb.	10.35
	245 RB *Roller Ball Contact for Closed Circuit Use	10	1/4 lb.	10.35
	246 RB *Roller Ball Contact for Make & Break Circuit	10	1/4 lb.	10.95
	*Low Voltage Only 48V AC Max.			

Catalog No.	Description	Std. Qty.	Pkg. Weight	List Price
AUDIBLE SIGNALS 8-16V AC, 3-6V DC				
	302 2 coil Bell, Concealed Terminals, 2½" Dia. Gong, Boxed	100	38 lbs.	12.50
	303 2 coil Bell, Concealed Terminals, 3" Dia. Gong, Boxed	10	5 lbs.	14.80
	304 2 coil Bell, Concealed Terminals, 4" Dia. Gong, Boxed	10	8 lbs.	16.80
	305 2 coil Buzzer, Concealed Terminals, Boxed	100	24 lbs.	10.10
	306 2 coil Bell, Concealed Terminals, 6" Dia. Gong	6	12 lbs.	56.80
TRANSFORMERS COMPLETE WITH GROUND WIRE 120V Primary, unless otherwise indicated				
	315 10 Volts, 5 VA 'Lock Nut Type'	50	47 lbs.	13.25
	319 6-12-18 Volts, Trivolt with 'Lock Nut Type' 6 Volts-10 VA 12 Volts-15 VA 18 Volts-15 VA	10	8 lbs.	25.75
	323 M Chime Transformer 16 Volts, 10 VA, with "Lock Nut Type"	50	47 lbs.	13.50
	323 M-15 Chime Transformer 16 Volts, 15 VA, with "Lock Nut Type"	25	23 lbs.	15.15

Catalog No.	Description	Std. Qty.	Pkg. Weight	List Price
TRANSFORMERS (Continued)				
330	Signaling Transformer, 50 VA Capacity, 120 Volts Primary 120V Secondary 50 VA @ 24V 25 VA @ 12V	1	4 lbs.	123.95
 340	Signaling Transformer, 100 VA Capacity, 120 Volts Primary 120V Secondary 100 VA @ 24V 50 VA @ 12V	1	5 lbs.	169.90
350	Signaling Transformer, 250 VA Capacity, 120 Volts Primary 120V Secondary 250 VA @ 24V 200 VA @ 20V 160 VA @ 16V 125 VA @ 12V 80 VA @ 8V 40 VA @ 4V	1	10 lbs.	409.80

AUDIBLE SIGNALS

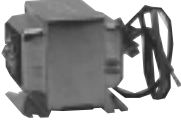
 410	Recessed Bell 8-12V AC	5	2 lbs.	24.75
 411	Recessed Buzzer 8-12V AC	5	2 lbs.	24.75
 412	Recessed Combination Bell-Buzzer, 8-12V AC	5	2 lbs.	35.70
 415	Recessed Bell and Push Combination, 8-12V AC	5	2 lbs.	32.40
416	Recessed Buzzer and Push Combination, 8-12V AC	5	2 lbs.	32.40
417	Recessed Combination Bell-Buzzer & Push, 8-12V AC	5	2 lbs.	38.50

Catalog No.	Description	Std. Qty.	Pkg. Weight	List Price
TRANSFORMERS (Continued) COMPLETE WITH GROUND WIRE				
592	Heavy Duty 8-16-24 Trivolt 8 & 16 Volts – 10 VA; 24 Volts – 20 VA 120V Primary	10	8 lbs.	23.50
 598	Heavy Duty 8-16-24 Trivolt 8 Volts – 20 VA; 16 & 24 Volts – 30 VA 120V Primary	10	16 lbs.	27.90
598Y	Heavy Duty 8-16-24 Trivolt 8 Volts – 20 VA; 16 & 24 Volts – 30 VA 240V Primary	5	5 lbs.	43.60
 599	Heavy Duty 24Volts – 40 VA 120V Primary	10	16 lbs.	29.05
599-P	Heavy Duty 24Volts – 40 VA 120V Primary with Plate	20	30 lbs.	32.00
599Y	Heavy Duty 24Volts – 40 VA 240V Primary	5	5 lbs.	47.90

HANGING BOXED PROJECT DOOR CHIMES



636 EMR BOX 2 Door Type – 16V AC	25	25 lbs.	13.85
----------------------------------	----	---------	-------

HANGING BOXED PROJECT DOOR CHIME KITS



636P-EMR-16-C 2 Door Chime w/ No. 323M – 16 Volts–10 VA Transformer, 2-No. 266LW Push Buttons. 7 ³ / ₈ " x 5" Cover fits over 2 Gang Box	24	50 lbs.	22.20
---	----	---------	-------

(A) 1 Door Kit with One 266LW Push Button		41 lbs.	16.70
---	--	---------	-------



Contact factory for quantity pricing and special Chime Kit Packs made to your requirements.



*694 B	Push Button Black Protruding Button, Snap Fit 5/8"	5	1/4 lb.	14.90
--------	--	---	---------	-------

*694 W	Push Button White Protruding Button, Snap Fit 5/8"	5	1/4 lb.	14.90
--------	--	---	---------	-------









*695 B	Push Button Black Protruding Button, Lock Nut Mtg. 5/8"	5	1/4 lb.	14.90
--------	---	---	---------	-------

*695 W	Push Button White Protruding Button, Lock Nut Mtg. 5/8"	5	1/4 lb.	14.90
--------	---	---	---------	-------

*Low voltage to 48V AC maximum.



Catalog No.	Description	Std. Qty.	Pkg. Weight	List Price
AUDIBLE SIGNALS (Continued)				
	800 6-10 V AC; 3-8 V DC	1	1/8 lb.	55.85
	800 A 24V AC	1	1/8 lb.	65.00
	801 6-12 V AC; 5-10 V DC	1	1/4 lb.	54.80
	801 A 24V AC	1	1/4 lb.	54.80
	802 6-12 V AC; 5-10 V DC	1	1/4 lb.	55.85
	802 A 24V AC	1	1/4 lb.	55.85
	*810 Brass Weatherproof Push Button	1	1/2 lb.	69.05
	*810 X Brass Weatherproof Push Button, with Conduit Plate *Low Voltage to 24V AC	1	1/2 lb.	75.50
	811 Cast Aluminum High Voltage Surface Type 120V AC Max.	1	1 lb.	107.00
	850 High Voltage Push Button 120V AC Max.	1	1/8 lb.	44.60
	852 High Voltage Push Button, Weatherproof 120V AC Max.	1	1/4 lb.	80.75
	870 A Adaptahorn, Flush Mount, 24V AC Indoor use only	1	2 lbs.	170.10
	870 B Adaptahorn, Flush Mount, 120V AC Indoor use only	1	2 lbs.	170.10
	870 BB Back Box for Flush Mounting of 870 A and 870 B	1	1 lb.	37.20
	872 A Projector Type, 24V AC Indoor use only	1	3 lbs.	163.70
	872 B Projector Type, 120V AC Indoor use only	1	3 lbs.	163.70
	872 A 876 Projector Type, 24V AC Weatherproof	1	4 lbs.	211.80
	872 B 876 Projector Type, 120V AC Weatherproof	1	4 lbs.	211.80
	874 A Grille Type, 24V AC Indoor use only	1	3 lbs.	134.60
	874 B Grille Type, 120V AC Indoor use only	1	3 lbs.	134.60
	874 A 876 Grille Type, 24V AC Weatherproof	1	4 lbs.	179.05
	874 B 876 Grille Type, 120V AC Weatherproof	1	4 lbs.	179.05

	Catalog No.	Description	Std. Qty.	Pkg. Weight	List Price
	950	Industrial Buzzer, 24V AC	1	2 lbs.	159.40
	951	Industrial Buzzer, 120V AC	1	2 lbs.	159.40
	952	Industrial Chime, 24V AC	1	3 lbs.	271.05
	953	Industrial Chime, 120V AC	1	3 lbs.	271.05
	1064 A	AC Buzzer, Strap Mounted, Fits 1-gang Box, 24V AC	1	¼ lb.	42.70
	1064 B	AC Buzzer, Strap Mounted, Fits 1-gang Box, 120V AC	1	¼ lb.	42.70
	1211	Magnet Reed Switch Contact Set, Closed Circuit 24V AC/DC Max.	5	½ lb.	14.35
	1224	Magnetic Reed Switch Contact Set, Open Circuit 24V AC/DC Max.	5	½ lb.	14.35
	1268	Make & Break Magnetic Switch – Surface Type 24V AC/DC Max.	5	½ lb.	17.30
	1268 cover	Protective Cover for Magnetic Switches	10	⅛ lb.	2.35 ea.
	1268 spacer	Insulating Spacer for Magnetic Switches	10	⅛ lb.	2.35 ea
	1882 A	Economy Wall Clock, 12" Surface Mount, Grey Case 120V AC – Plug In	6	21 lbs.	86.70

Catalog
No.

Description

Std.
Qty.

Pkg.
Weight

List
Price

VIBRATING BELLS

+ For general signaling purposes only. Not for fire usage.

3200+

Vibrating Bells, AC Operation, 60 Cycles. Note: Specify Gong Size & Voltage.



4" Gong Size -	12V AC*	5	5 lbs.	112.35
	24V AC	5	5 lbs.	112.35
	120V AC	5	5 lbs.	112.35
	240V AC	5	5 lbs.	112.35
6" Gong Size -	12V AC*	5	15 lbs.	128.40
	24V AC	5	15 lbs.	128.40
	120V AC	5	15 lbs.	128.40
	240V AC	5	15 lbs.	128.40
8" Gong Size -	12V AC*	1	3 lbs.	142.00
	24V AC	1	3 lbs.	142.00
	120V AC	1	3 lbs.	142.00
	240V AC	1	3 lbs.	142.00
10" Gong Size -	12V AC*	1	4 lbs.	155.55
	24V AC	1	4 lbs.	155.55
	120V AC	1	4 lbs.	155.55
	240V AC	1	4 lbs.	155.55

Use prefix WP for Weatherproofing—Model 3200, Add
(Not Available Separately)

24.70 ea.

*Requires minimum of 25 VA.

INDOOR OPERATION ONLY. Note: Specify Gong Size & Voltage.

3600+

Economy Line, Vibrating Bells, AC Operation



4" Gong Size -	12V AC*	5	5 lbs.	74.10
	24V AC	5	5 lbs.	74.10
	120V AC	5	5 lbs.	74.10
6" Gong Size -	12V AC*	5	15 lbs.	75.55
	24V AC	5	15 lbs.	75.55
	120V AC	5	15 lbs.	75.55
8" Gong Size -	12V AC*	1	3 lbs.	97.55
	24V AC	1	3 lbs.	97.55
	120V AC	1	3 lbs.	97.55
10" Gong Size -	12V AC*	1	4 lbs.	103.70
	24V AC	1	4 lbs.	103.70
	120V AC	1	4 lbs.	103.70

No Back Box Furnished.

For Red Gong—Models 3200, 3600, Add

12.35

*Requires minimum of 25 VA.

Display for BC285LB - BC290LB

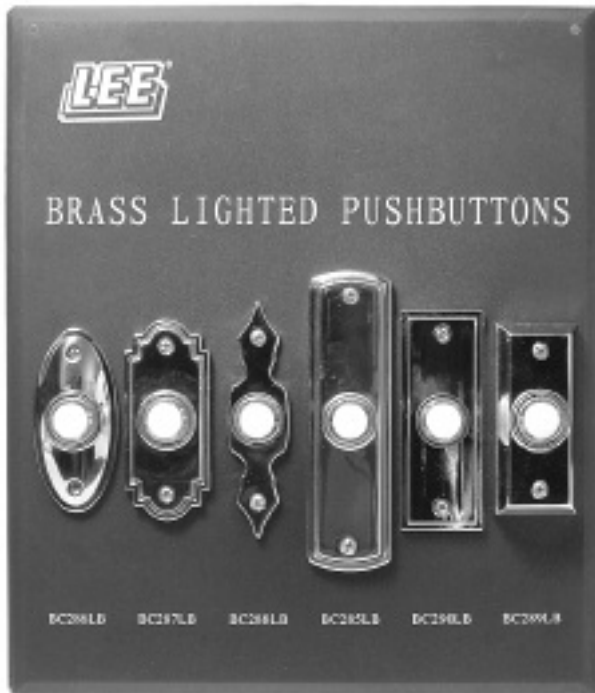

Get this push button display FREE with your order of (6) six each Catalog Nos. BC 285LB through BC 290LB, featured on pages 4 and 5.

Ask for a FREE Push Button Display Board and Hooks. Holds 12 styles of blister carded push buttons. Size: 15" x 26". (Push buttons not included.)



Size: 2' x 4'; 2 Sections

Get this display FREE with your order of (3) each of Catalog Numbers: BC 1032, BC 1035, BC 1036, BC 1050, BC 1051, BC 1054, BC 1055, and BC 1056.

This colorful working display is the perfect way to show potential customers the LEE chimes that are available for purchase.

Display for BC293LSS - BC293LWBZ



Get this push button display FREE with your order of (6) six each Catalog Nos. BC 293LSS through BC 293LWBZ, featured on page 5.

Notes



Quality Electrical Devices

